

ELCOFIRE SOL THREE SIDED VIEWING ELECTRIC FIREPLACE

Model# : ■ EFS1300 ■ EFS1600

OWNER'S MANUAL

elcofire

BEYOND EXPECTATION



52"/63" Built-in Electric Fireplace

AC 220V-240V 50Hz 1400-1600W

⚠ WARNING

Read and understand this entire owner's manual, including all safety information, before plugging in or using this product. Failure to do so could result in fire, electric shock, or serious personal injury.

⚠ CAUTION

Keep this owner's manual for future reference. If you sell or give this product away, make sure this manual accompanies this product.

**UK
CA** **CE**

IMPORTANT SAFETY INFORMATION!

WARNING

When using electrical appliances basic precautions should always be followed to reduce the risk of fire, electric shock and injury to persons, including the following:

- Read all instructions before using this heater.
- This heater is hot when in use. To avoid burning, do not touch hot surface. If provided, use handles when moving this heater. Keep combustible materials, such as furniture, pillows, bedding, papers, clothes, and curtains at least 1 m from the front of the heater and keep them away from the sides and rear. In order to avoid overheating, do not cover the heater.
- Extreme caution is necessary when any heater is used near children or the infirm and whenever the heater is left operating and unattended.
- Always unplug heater when not in use.
- Do not operate any heater with a damaged cord or plug or after the heater malfunctions, has been dropped damaged in any manner, return heater to authorized service facility for examination, electrical or mechanical adjustment, or repair.
- Indoor use only, do not use outdoors.
- This heater is not intended for use in bathrooms, laundry areas and similar indoor locations. Never locate heater where it may fall into a bathtub or other water container.
- Do not run cord under carpeting. Do not cover cord with throw rugs, runners, or similar coverings. Arrange cord away from traffic area and where it will not be tipped over.
- To disconnect heater, turn controls to off, then remove plug from outlet.
- Do not inset or allow foreign objects to enter any ventilation or exhaust opening as this may cause an electric shock or fire, or damage the heater.
- To prevent a possible fire, do not block air intakes or exhaust in any manner. Do not use on soft surfaces, like a bed, where openings may become blocked.
- A heater has hot and arcing or sparking parts inside. Do not use it in areas where gasoline, or flammable liquids are used or stored.
- Use this heater only as describes in this manual. Any other use not recommended by the manufacturer may cause fire, electric shock, or injury to persons.
- DANGER-HIGH Temperatures may be generated under certain abnormal conditions. Do not partially or fully cover or obstruct the front of this heater.
- Replacement of the lamps should be done only while the heater is disconnected from the supply circuit.
- This appliance is not intended for use by persons (including children) with reduced physical, sensory or capabilities, or lack of experience and knowledge, unless they have been given supervision or instruction concerning use of the appliance by a person responsible for their safety. Children should be supervised to ensure that they do not play with the appliance.
- CAUTION: In order to avoid a hazard due to inadvertent resetting of the thermal cut-out, this appliance must not be supplied through an external switching device, such as a timer, or connected to a circuit that is regularly switched on and off by the utility.

Preparation









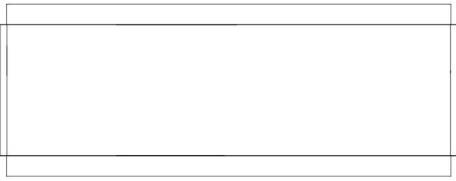

This product includes a **GLASS panel!** Always use **extreme caution** when handling **glass**. Failure to do so could result in **personal injury** or **property damage**.

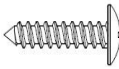
Remove all parts and hardware from the carton and place them on a clean, soft, dry surface. Parts and assembly steps are grouped for wall-hanging or recessing use. Check the parts list to make sure nothing is missing. Dispose of packaging materials properly. Please recycle whenever possible.

You will need the following tools (not included): Phillips screwdriver; stud finder; level; tape measure; electric drill; 1/4" wood drill bit, hammer.

Parts and Hardware

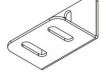
 <p>A – Fireplace</p>			
	<p>B-Wood Screws</p>		<p>C- Drywall anchors</p>
			
	<p>D-Remote Control</p>	<p>E-Lit Log-set</p>	
			
<p>F-Smoky Crystal</p>	<p>G-Vermiculite-Black</p>	<p>H-Vermiculite-Beige</p>	<p>I- "L" bracket</p>

Specification and Dimension

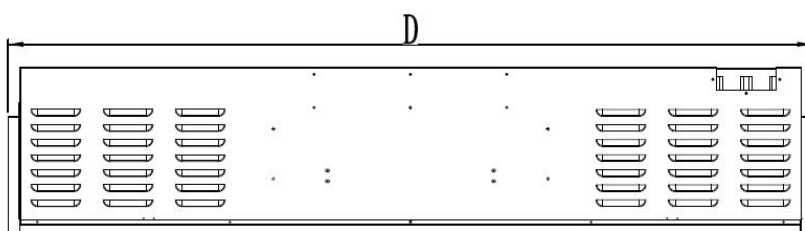
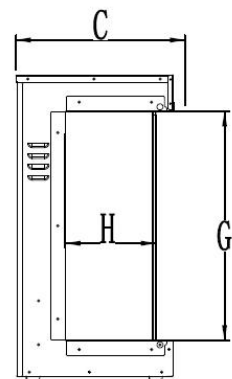
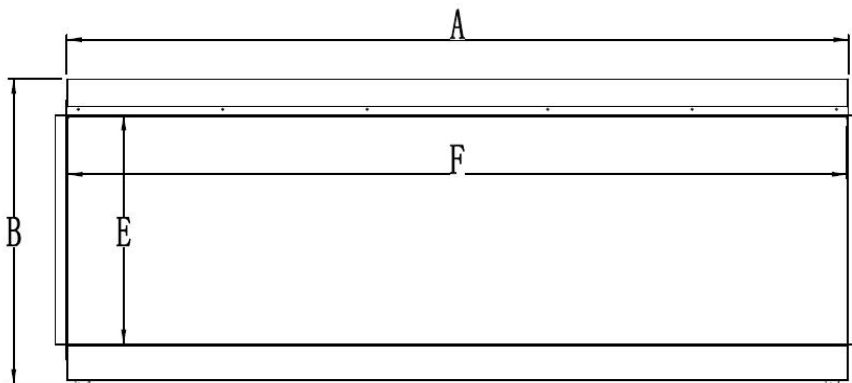

PRODUCT DIMENSIONS

Model No	A	B	C	D	E	F	G	H
EFS1300	1300mm	506mm	298mm	1336mm	381mm	1295mm	381mm	152mm
EFS1600	1600mm	506mm	298mm	1636mm	381mm	1595mm	381mm	152mm

Installation and Assembly

Your appliance is a wall-mounted, recessed appliance. Select a suitable location that is not susceptible to moisture and is away from drapes, furniture and high traffic areas.

NOTE: Follow all National and local electrical codes. The Electric fireplace comes with the power plug supplied, to switch to hard-wiring, please refer to hard-wiring installation section.

MINIMUM CLEARANCE TO COMBUSTIBLES

Measurements are taken from the glass front.

Bottom	0"	Top	11.8" (300mm) to mantel
Sides	0"	Top	11.8" (300mm) to ceiling
Back	0"		

Installation Overview

Your appliance facilitates three different installation configurations: **three-sided**, **two-sided**, and **single-sided**.

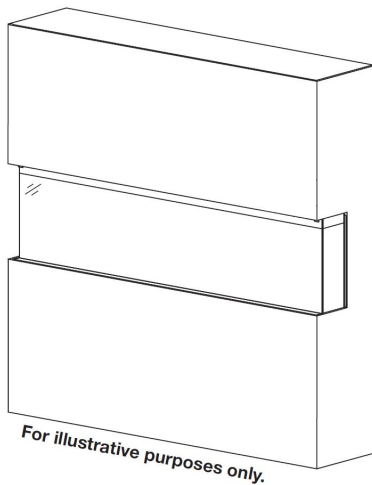

Three-sided installation

- Glass exposed on front, left, AND right sides.
- Appliance is fully recessed into the wall with both sides open.

Two-sided installation

- Glass exposed on front AND left OR right sides.
- Appliance is fully recessed into the wall with one side open.

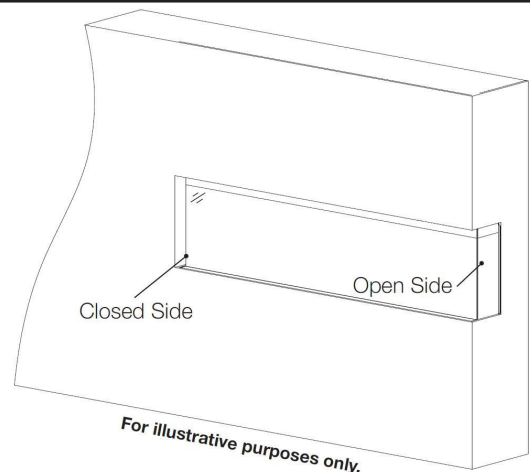

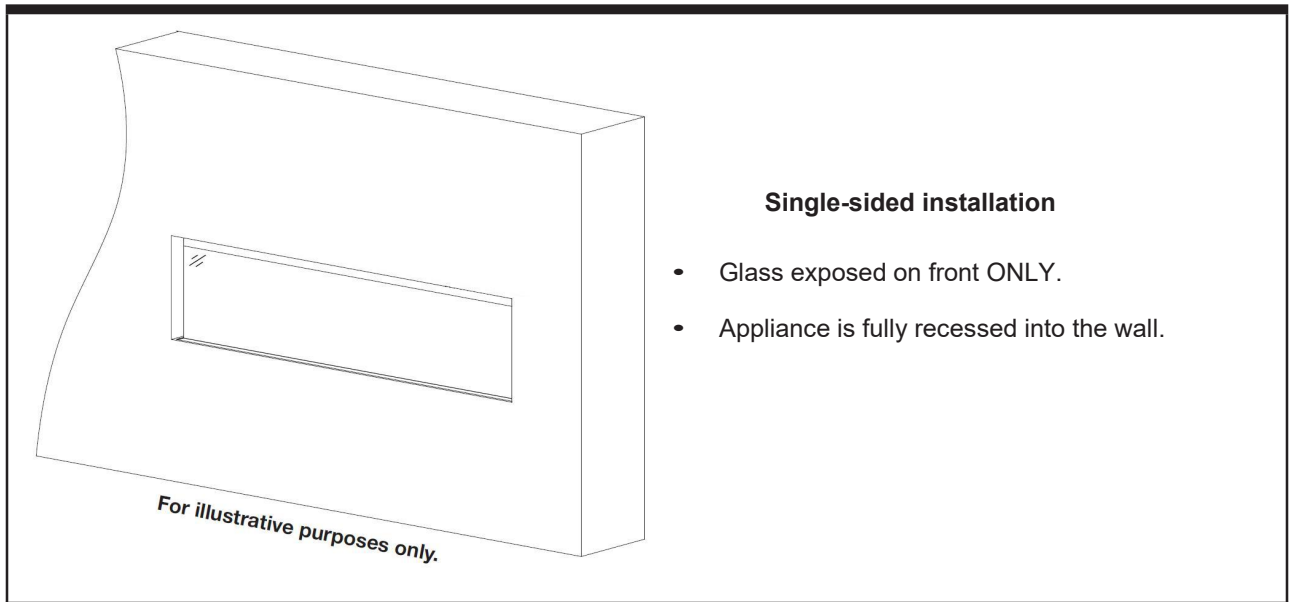

Front Glass Installation / Removal

- Take off all screws from the top the glass panel. Fig.1-1
- Tilt the front glass forwards, and have two people to move out the glass panel. Fig.1-2
- Reverse these steps to re-install the front glass.

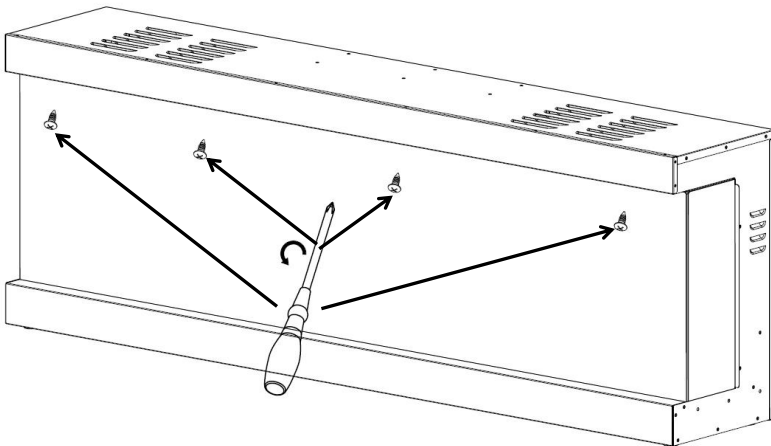

Fig.1-1

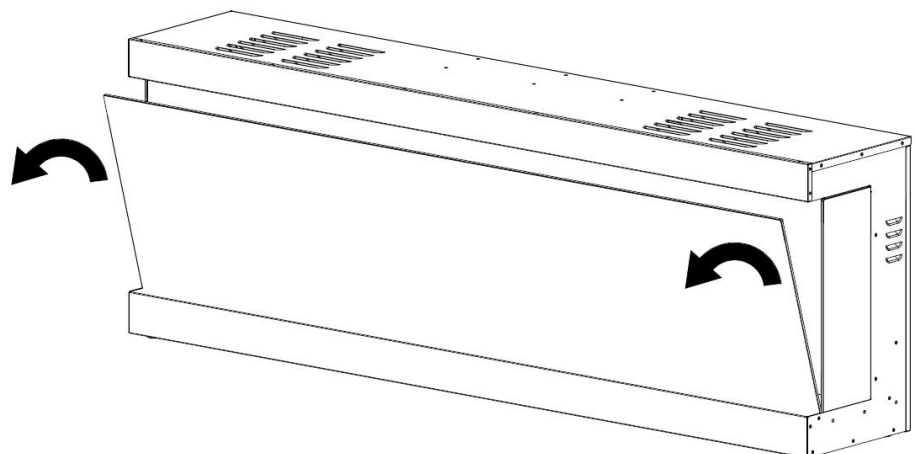
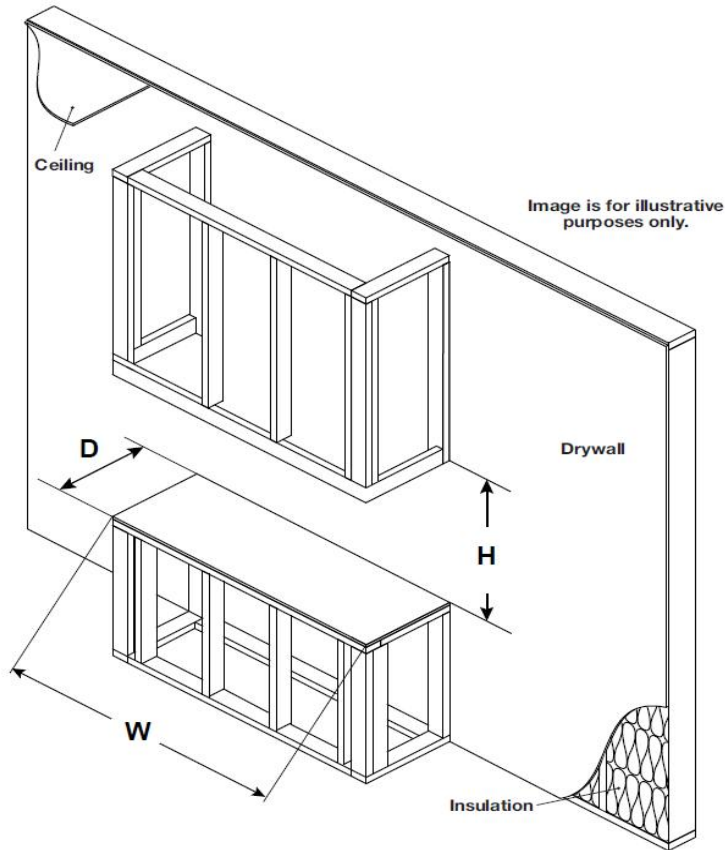

Fig.1-2

Installation - Rough Framing



Model Number	W	D	H
EFS1300	1305mm	290mm	512mm
EFS1600	1605mm	290mm	512mm

Note:

Appliance is NOT load-bearing. Carefully consider weight of finishing materials when constructing rough framing.

Ensure installation complies with all local building codes and requirements.

All viewing options (single-sided, two-sided [left or right], and three-sided) use the same framing dimensions.

Installation - Fending bar and panel

1. The fireplace is fixed with fending bars and panels on the left and right side. Fig.2-1,2-2

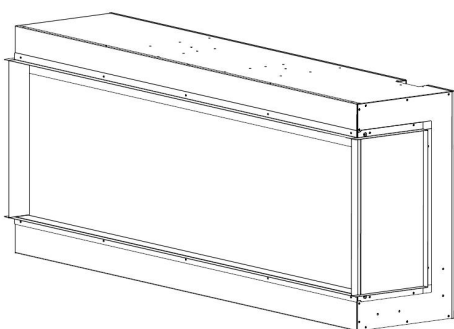

Fig.2-1

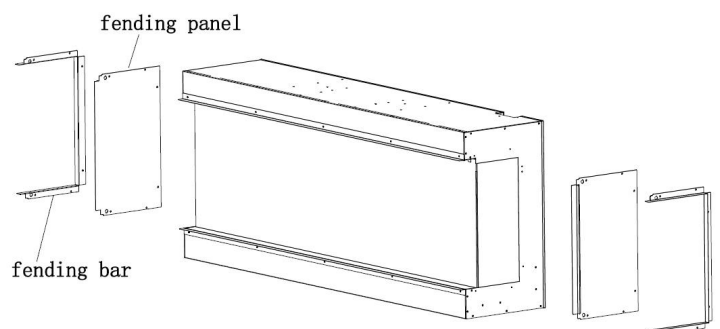

Fig.2-2

2. Take off the fending bars and panels if you want to view the fire from three sides. Fig.2-3

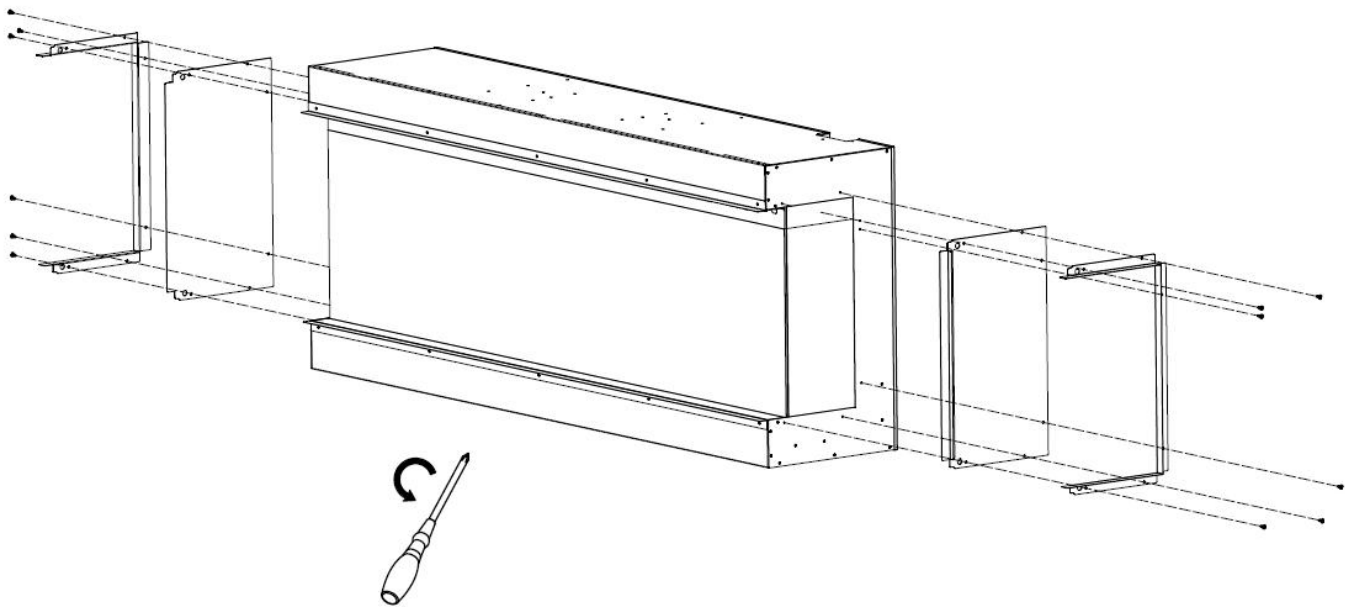

Fig.2-3

3. Fix back the fending bars after the panels are removed. Fig.2-4

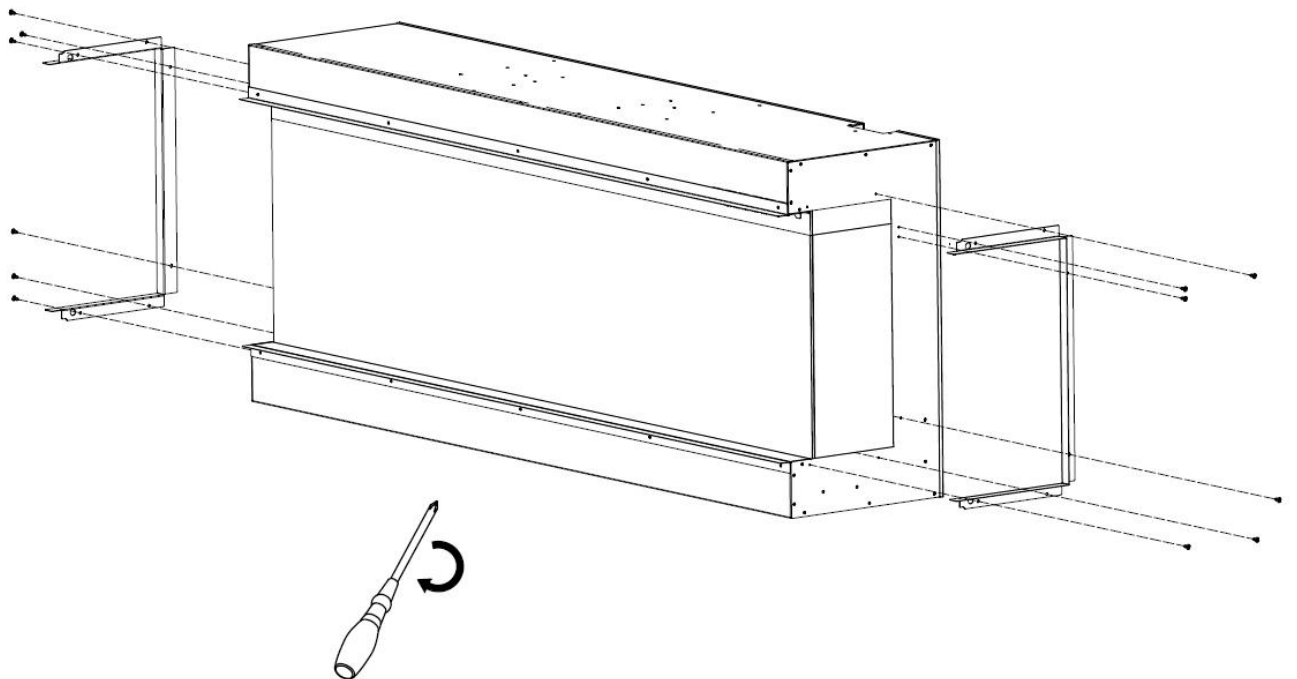

Fig.2-4

4.Remove the screws from the fireplace as shown in the picture below. Fig.3-1

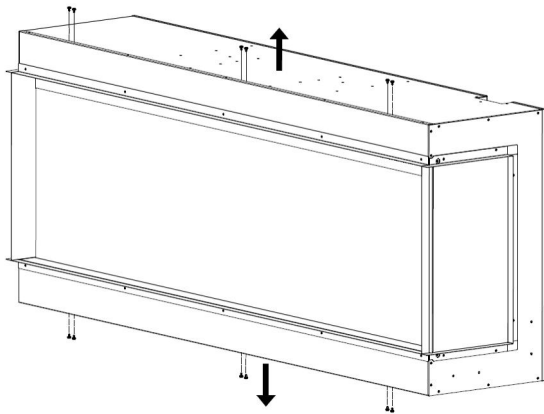

Fig.3-1

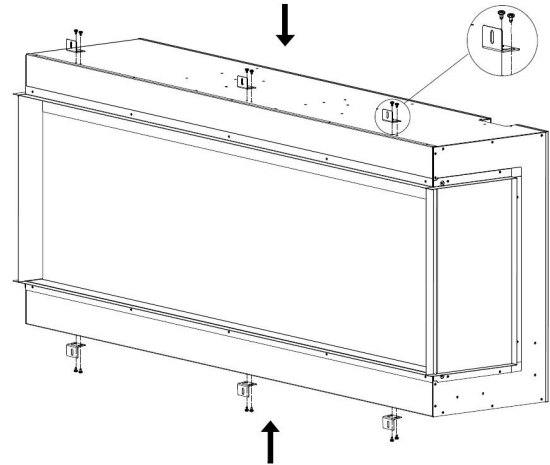

Fig.3-2

5.Fix the brackets with the screws in the previous step. Fig.3-2

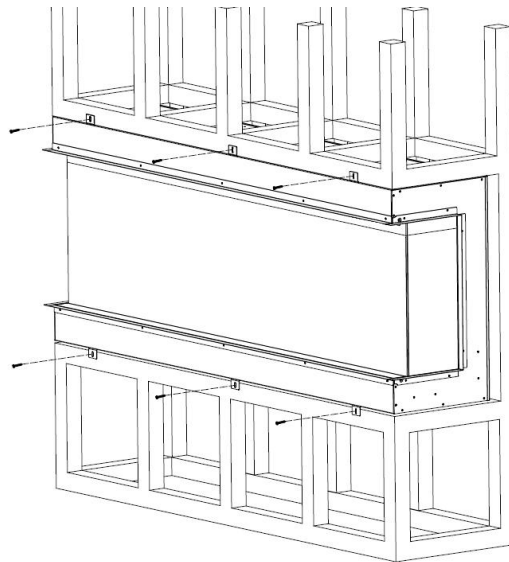

Fig.3-3

6.Insert the fireplace into the wall opening. Drive the mounting screws into the brackets and the wall studs. Plug in and check if the fireplace works properly.Fig.3-3

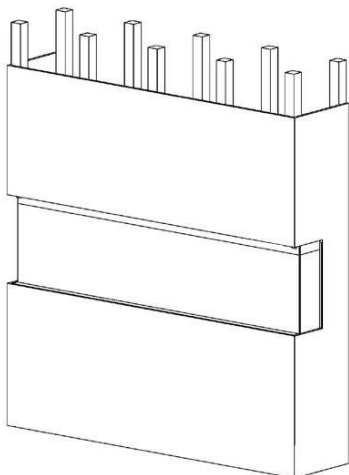

Fig.3-4

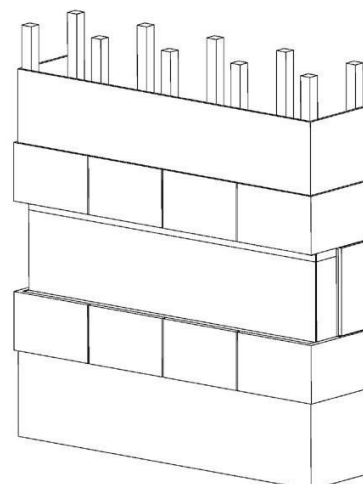

Fig.3-5

7.Cover the glass panel with protective plastic bag and install plywood or drywall. Fig.3-4

8.Decorate the plywood or drywall with glazed tile,wallpaper, etc. Fig.3-5

Log-set /Smoky Crystal /Vermiculite Installation

- A. Glass front must be removed and the appliance must be mounted in its final location before the fuel-bed media are installed.
- B. Plug the Lit Log-set to the power connectors and try to settle all connecting wires to be invisible from front. **Fig.4-1**
- C. Carefully place the smoky crystal and vermiculite fuels into the bottom tray around the log-set as illustrated. Apply an even layer from side to side. **Fig. 4-2**
- D. Re-install the front glass.

Log-set Layout for EFS1300



Fig. 4-1 (FOR EFS1300)

Carefully place the smoky crystal and vermiculite fuels into gaps around the log-set **Fig.4-2**



Fig.4-2 (FOR EFS1300)

Log-set Layout for EFS1600

Plug the Lit Log-set to the power connectors and try to settle all connecting wires to be invisible from front. **Fig.5-1**

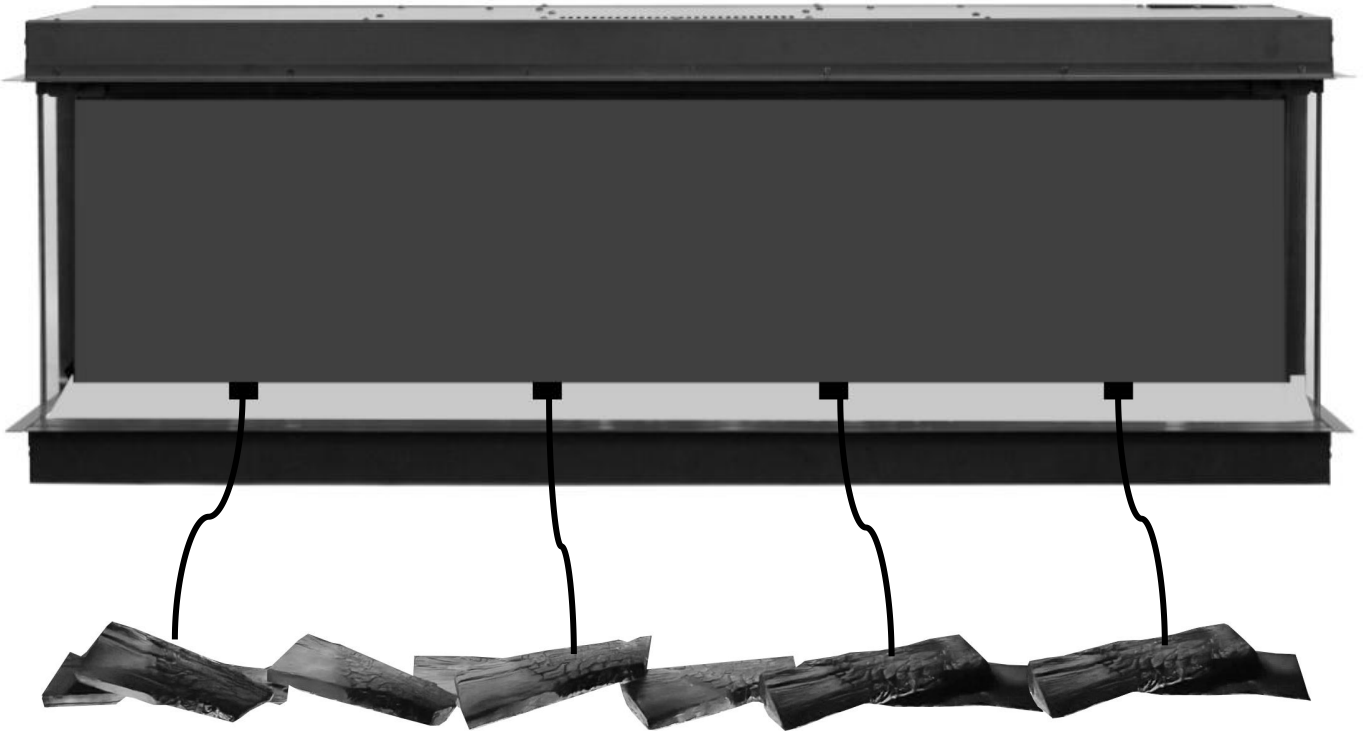

Fig. 5-1 (FOR EFS1600)

Carefully place the smoky crystal and vermiculite fuels into gaps around the log-set **Fig.5-2**

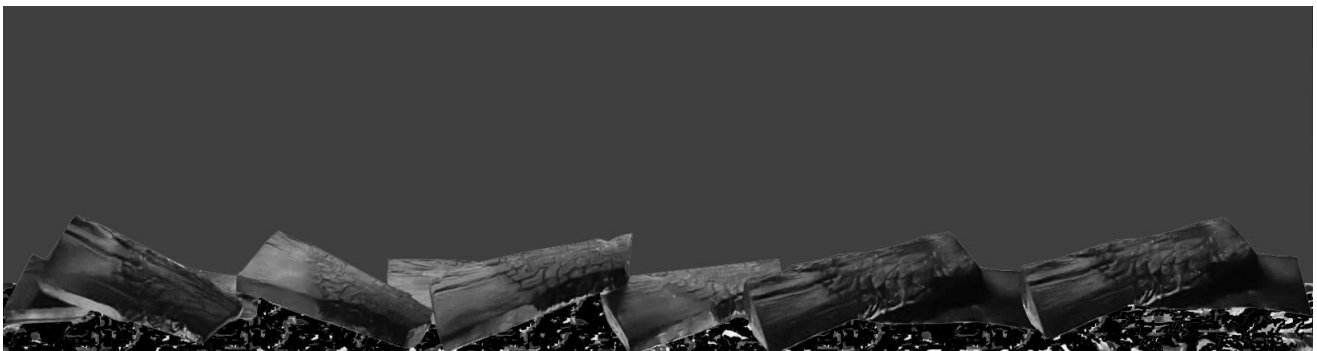

Fig.5-2 (FOR EFS1600)

Operation



Read and understand this entire owner's manual, including all safety information, before plugging in or using this product. Failure to do so could result in electric shock, fire, serious injury, or death.

Power

Plug the power cord into a AC 220-240 Volt outlet (see **IMPORTANT SAFETY INFORMATION** on Pages 2 and 3). Make sure the outlet is in good condition and that the plug is not loose. **NEVER** exceed the maximum amperage for the circuit. **DO NOT** plug other appliances into the same circuit.

Methods of Operation

This electric fireplace can be operated by the Manual CONTROL PANEL, or by the battery-powered REMOTE CONTROL.

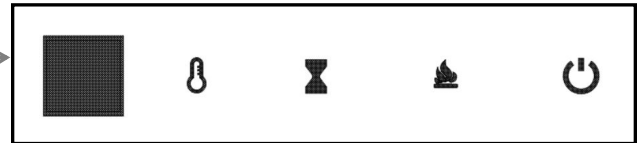

Before operating, please review the **IMPORTANT SAFETY INFORMATION** on Pages 2 and 3, and heed all warnings.



Manual Control Panel

Touch Control Panel Operation



BUTTON	FUNCTION	ACTION & INDICATION																																													
 POWER	<p>ON: Enables control panel functions and remote control. Turns on flame effect.</p> <p>OFF: Disables control panel functions and remote control. Turns off flame effect.</p>	<p>1. Press once. Indicator light turns on. Power turns on. All functions enabled.</p> <p>2. Press again. Flame effect turns off. Unit goes to standby. All functions turn off.</p>																																													
 TEMP	<p>1. Press once: Touch panel indicator becomes active.</p> <p>2. Press again until desired setting is reached. Digital display shows setting circles as below.</p> <table border="1"> <thead> <tr> <th>NO</th> <th>0</th> <th>1</th> <th>2</th> <th>3</th> <th>4</th> <th>5</th> <th>6</th> <th>7</th> <th>8</th> <th>9</th> <th>10</th> <th>11</th> <th>12</th> <th>N</th> </tr> </thead> <tbody> <tr> <td>°C</td> <td>18</td> <td>19</td> <td>20</td> <td>21</td> <td>22</td> <td>23</td> <td>24</td> <td>25</td> <td>26</td> <td>27</td> <td>28</td> <td>29</td> <td>30</td> <td>C</td> </tr> <tr> <td>°F</td> <td>64</td> <td>66</td> <td>68</td> <td>70</td> <td>72</td> <td>74</td> <td>76</td> <td>78</td> <td>80</td> <td>82</td> <td>84</td> <td>86</td> <td>88</td> <td>F</td> </tr> </tbody> </table>	NO	0	1	2	3	4	5	6	7	8	9	10	11	12	N	°C	18	19	20	21	22	23	24	25	26	27	28	29	30	C	°F	64	66	68	70	72	74	76	78	80	82	84	86	88	F	<p>NOTE: Press the button for 5 seconds to switch between ° C and ° F</p>
NO	0	1	2	3	4	5	6	7	8	9	10	11	12	N																																	
°C	18	19	20	21	22	23	24	25	26	27	28	29	30	C																																	
°F	64	66	68	70	72	74	76	78	80	82	84	86	88	F																																	







 TIMER	<p>TIMER button: Controls timer settings to turn off fireplace at selected time. Settings range from 0.5 hours to 8 hours.</p>	<ol style="list-style-type: none"> Press once. Indicator light turns on. Timer is set to 0.5 hours. Press again until desired setting is reached. Indicator lights show setting.
 FLAME COLOR	<p>Flame color button: Makes the color flame effect changing. NOTE: color effect stays on until power button is turned off. Color flame effect must be on for heater to turn on. NOTE: this fireplace is with memory function for flame.</p>	<ol style="list-style-type: none"> Press once. Flame color effect gets changing. Press again until desired setting is reached. In total 6 colors for flame.

Press and hold the power button for 5s to be paired your remote control with your fireplace.
433MHZ (0.1W)







Remote Control Operation



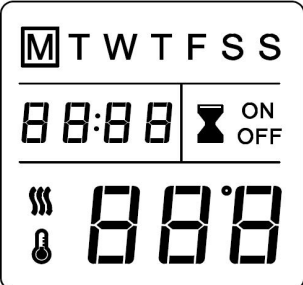

BUTTON	FUNCTION	ACTION & INDICATION																																													
 POWER	<p>ON: Enables control panel functions and remote control. Turns on flame effect. OFF: Disables control panel functions and remote control. Turns off flame effect.</p>	<ol style="list-style-type: none"> Press once. Indicator light turns on. Power turns on. All functions enabled. Press again. Flame effect turns off. Unit goes to standby. All functions turn off. 																																													
 FLAME	<p>COLOUR buttons: Makes the colour flame effect changing. NOTE: Colour effect stays on until power button is turned off. Colour flame effect must be on for heater to turn on.</p>	<ol style="list-style-type: none"> Press blue button to control the blue flame and flame brightness. Press red button to control the orange flame and flame brightness. Press yellow button to control the yellow flame and flame brightness. 																																													
 TEMP	<ol style="list-style-type: none"> Press once: Touch panel indicator becomes active. Press again until desired setting is reached. Digital display shows setting circles as below. <table border="1" data-bbox="272 1707 1516 1829"> <tr> <td>NO</td> <td>0</td> <td>1</td> <td>2</td> <td>3</td> <td>4</td> <td>5</td> <td>6</td> <td>7</td> <td>8</td> <td>9</td> <td>10</td> <td>11</td> <td>12</td> <td>N</td> </tr> <tr> <td>°C</td> <td>18</td> <td>19</td> <td>20</td> <td>21</td> <td>22</td> <td>23</td> <td>24</td> <td>25</td> <td>26</td> <td>27</td> <td>28</td> <td>29</td> <td>30</td> <td>C</td> </tr> <tr> <td>°F</td> <td>64</td> <td>66</td> <td>68</td> <td>70</td> <td>72</td> <td>74</td> <td>76</td> <td>78</td> <td>80</td> <td>82</td> <td>84</td> <td>86</td> <td>88</td> <td>F</td> </tr> </table> <p>NOTE: Press the button for 5 seconds to switch between ° C and ° F</p>		NO	0	1	2	3	4	5	6	7	8	9	10	11	12	N	°C	18	19	20	21	22	23	24	25	26	27	28	29	30	C	°F	64	66	68	70	72	74	76	78	80	82	84	86	88	F
NO	0	1	2	3	4	5	6	7	8	9	10	11	12	N																																	
°C	18	19	20	21	22	23	24	25	26	27	28	29	30	C																																	
°F	64	66	68	70	72	74	76	78	80	82	84	86	88	F																																	

 TIMER	<p>TIMER button: Controls timer settings to turn off fireplace at selected time.</p> <p>Settings range from 0.5 hours to 8 hours.</p>	<ol style="list-style-type: none"> Press once. Indicator light turns on. Timer is set to 0.5 hours. Press again until desired setting is reached. Indicator lights show setting.
 FLAME SPEED	<p>Flame speed button: Controls the speed of the flame. There are 3 flame speed settings: 01 (slowest), 02 (Medium), 03 (fastest).</p>	<ol style="list-style-type: none"> Press once. Flame speed gets changing. Press again until desired setting is reached. Display shows the setting. <p>The Default setting is 03 (fastest speed)</p>
 FUEL BED COLOUR	<p>LED Ember light button: Makes the colour on bottom effect gets changing.</p> <p>NOTE: Ember color effect stays on until power button is turned off.</p>	<ol style="list-style-type: none"> Press once. LED ember light colour effect gets changing. Press again until desired setting is reached. In total 3 colour for ember bed.
 FUEL BED BRIGHTNESS	<p>LED Ember light brightness button: Makes the LED ember light brightness gets changing.</p> <p>NOTE: LED Ember light brightness effect stays on until power button is turned off.</p>	<ol style="list-style-type: none"> Press once. LED ember light brightness effect gets changing. Press again until desired setting is reached. In total 5 levels. <p>From b4 - b3- b2- b1 - b5 (Pulsating)</p>
 DOWN-LIGHT COLOUR	<p>LED Down light button: Makes the colour on top gets changing.</p> <p>NOTE: LED down light color effect stays on until power button is turned off.</p>	<ol style="list-style-type: none"> Press once. LED down light colour effect gets changing. Press again until desired setting is reached. In total 3 colour for down-light.
 HEATER	<p>HEATER button: Turns heater on and off.</p> <p>NOTE: To prevent overheating, the heater fan will blow cool air for 8-10 seconds after the heater turns off.</p>	<p>Press the heater button to set fireplace heating mode:</p> <p>H-0: Heater and Blower Off</p> <p>H-1: Low Heater On (750W)</p> <p>H-2: High Heater On (1500W)</p>
 Fire Cracker	<p>Fire Cracking Sound button: Controls the sound of the fire cracker speaker.</p> <p>There are 4 sound level settings: Low, Medium, High, off</p>	<ol style="list-style-type: none"> Press once. Fire cracker sound gets changing. Press again until desired setting is reached. <p>The Default setting is High</p>



TIMER SETTINGS ON REMOTE CONTROL

 : Timer: Displays current day, time, and week. Press to enter or confirm timer settings.		
OK : Settings: Press to move to next step (use with Timer button). Press to confirm week timer.		
 : Back: Press to clear timer settings. Press to return to the previous step (use with Settings button).		
 : Up and Down (use with Settings button).		
LCD Screen		
Weekday _____ Mon, Tues, Wed, Thurs, Fri, Sat, Sun		<p>Note: The functions can only be adjusted when the related letters or digits are flashing.</p> <p>Note: Calibrate the timer to current time before the weekly settings.</p>
Time Display _____		
Current Time / Timer From 00:00 to 24:00 NOTE: 00-12:00 is AM / 13:00-24:00 is PM		

1 Set current day and time



1. Press  once. When "MON" (Monday) begins flashing, use  to selected current day. Press **OK** to complete the setting.
2. When the hour digits begin flashing, use  to select the current hour. Press **OK** to complete the setting.
3. When the minute digits begin flashing, use  to select the current minute. Press **OK** to complete the setting.

2 Set ON/OFF time and temperature on a weekly cycle

1. Press  once. When "MON" (Monday) begins flashing, use  to selected current day. Press **OK** to complete the setting.



note:

The timer can only be adjusted in 30-minute intervals (i.e. 00:00 - 00:30; 00:30 - 01:00, etc.)

2. When "--:--" begins flashing, use  to select the desired hour and minutes to turn on the heater. Press **OK** to complete the setting. Press  any time to clear the digits and shut down "ON" timer.
3. When "18" begins flashing, use  to selected the desired temperature to turn on the heater for Monday.

note:

If the temperature was previously set, those digits will be shown instead of "18".

4. When "--:--" begins flashing, use  to select the desired hour and minutes to turn off the heater. Press **OK** to complete the setting. Press  at any time to clear the digits and shut down "OFF" timer.

- Repeat steps 1 to 4 to set the “ON/OFF” time and temperature for Tuesday, Wednesday, Thursday, Friday, Saturday, and Sunday.
- Press **OK** to complete programming, ensuring to aim the remote control at the receiver, located in the middle of the appliance. The appliance will “beep” once to confirm that programming has been successful.

Open window warning

If the room temperature decreases by 10 degrees within 3 minutes, the appliance will assume there is an open window nearby. In order to conserve energy, the heater will automatically switch from High Heat to Low Heat, or if the heater is already at Low Heat, it will turn off completely.

When switching from High Heat to Low Heat, the appliance will beep 3 times and the digital display will flash “88” 3 times before displaying the existing heating status.

When switching from Low Heat to Off, the appliance will beep 3 times and the digital display will flash “88” continuously. To reset the heating function, see “operating remote control” section.

Temperature Limiting Control

This heater is equipped with a Temperature Limiting Control. Should the heater reach an unsafe temperature, the heater will automatically turn OFF. To reset:

- Unplug the power cord from the outlet.
- Turn the ON/OFF switch on the CONTROL PANEL to OFF. **Wait 5 minutes.**
- Inspect the fireplace to make sure no vents are blocked, or clogged with dust or lint. If they are, use a vacuum to clean the vent areas.
- With the POWER switch in the OFF position, plug the power cord back into the outlet.
- If the problem continues, have your outlet and wiring inspected by a professional.

Remote Control Battery Information

- Remote control uses two AAA batteries (**NOT Included**)



NEVER dispose of batteries in **fire**. Failure to observe this precaution **may result in an explosion**. Dispose of batteries at your local hazardous material processing center.

Care and Maintenance

Cleaning



ALWAYS turn the heater **OFF** and **unplug the power cord from the outlet** before cleaning, performing maintenance, or moving this fireplace. Failure to do so could result in **electric shock, fire, or personal injury**.



NEVER immerse in **water** or **spray with water**. Doing so could result in **electric shock, fire, or personal injury**.

Metal:

- Buff using a soft cloth, slightly dampened with a citrus oil-based product.
- **DO NOT** use brass polish or household cleaners as these products will damage the metal trim.

Glass:

- Use a good quality glass cleaner sprayed onto the cloth or towel. Dry thoroughly with a paper towel or lint-free cloth.
- **NEVER** use abrasive cleansers, liquid sprays, or any cleaner that could scratch the surface.

Vents:

- Use a vacuum or duster to remove dust and dirt from the heater and vent areas.

Plastic:

- Wipe gently with a slightly damp cloth and a mild solution of dish soap and warm water.
- **NEVER** use abrasive cleansers, liquid sprays, or any cleaner that could scratch the surface.

Maintenance



Risk of electric shock! DO NOT OPEN any panels ! No user-serviceable parts inside!



ALWAYS turn the heater **OFF** and **unplug the power cord from the outlet** before cleaning, performing maintenance, or moving this fireplace. Failure to do so could result in **electric shock, fire, or personal injury.**

Electrical and Moving Parts:

- The fan motors are lubricated at the factory and will not require lubrication.
- Electrical components are integrated in the fireplace and are not serviceable by the consumer.

Storage:

- Store heater in a clean dry place when not in use.



WARNING! NO SERVICING of the internal or electrical parts should be performed by the consumer. Do not service the unit yourself.



WEEE:

Meaning of crossed –out wheeled dustbin:

Do not dispose of electrical appliances as unsorted municipal waste, use separate collection facilities. Contact you local government for information regarding the collection systems available. If electrical appliances are disposed of in landfills or dumps, hazardous substances can leak into the groundwater and get into the food chain, damaging your health and well-being.

When replacing old appliances with new ones, the retailer is legally obligated to take back your old appliance for disposals at least free of charge.

APP Connecting Instruction

1. App download

- Download "Tuya Smart" from the app store.
- Scan the QR code.
- Turn on the "GPS" from your mobile device.



NOTE Make sure your mobile phone is well connected to the nearest WIFI signal. Only one device can be paired through the APP at a time.

2. Login

- Register with your email ID or Mobile phone number as the user name.
- Setup your account password.

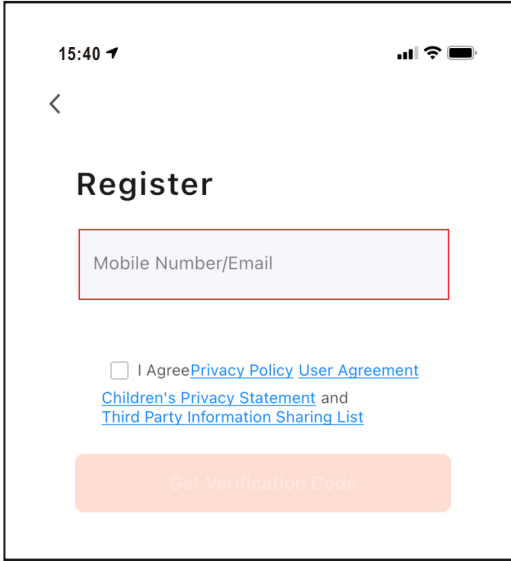

3. Add device

After account is created, log into account and select the "Add Device" button.

There are three methods to add your Electric Fireplace.

- Method 1: Add by Bluetooth. Open Bluetooth on your mobile phone before adding.
- Method 2: Add Manually on "P0" mode. Please follow below steps A,B,C,D.
- Method 3: Add Manually on "P2" mode. Please follow below steps A,B,C,D.

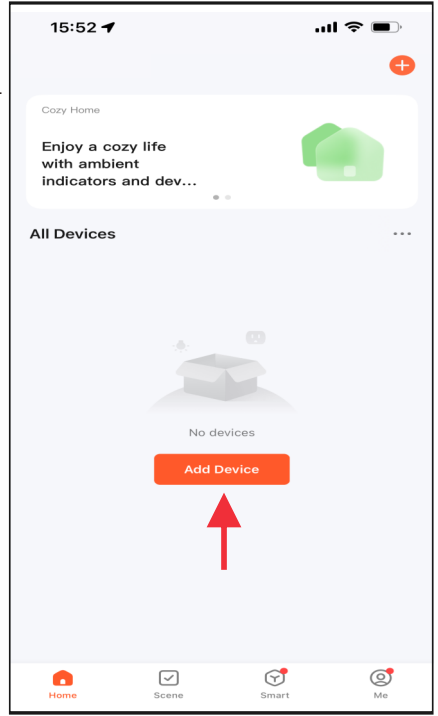

Add device - Method 1 (Bluetooth)

- Press the **Add** button when you see the device named "Elco Fire".
- Enter the WIFI name and password, then press "Next" button for pairing.
- When complete, display on control panel shows "P4", LED Ember-light shows GREEN color and flashes 6 times.

IMPORTANT INFORMATION

- Turn on the Blue-tooth device with your mobile phone.
- Connect your mobile phone with WIFI signal.

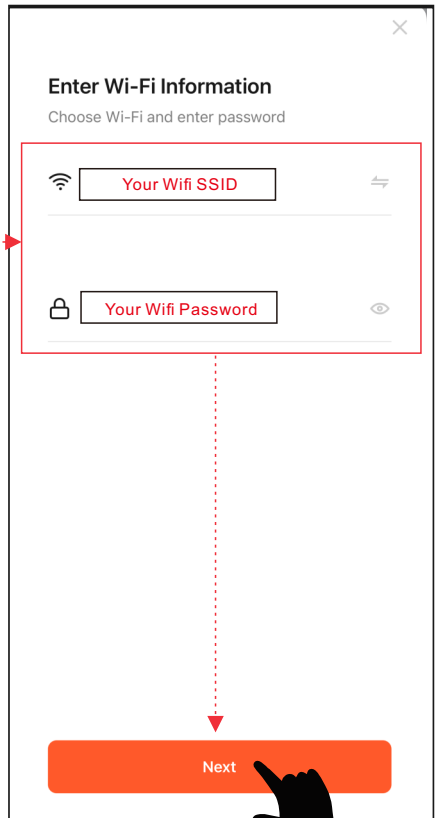
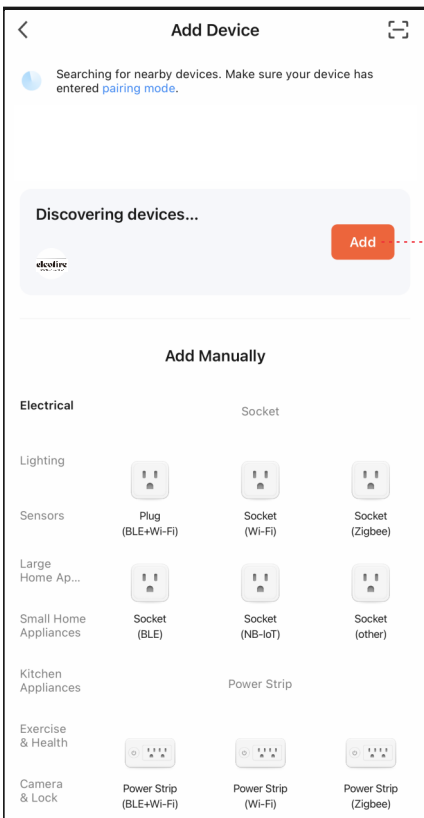

Add device - method 2 - (P0)

- Press & hold  from remote control or control panel until display on control panel shows "P0". Then follow below steps A,B,C,D.
- Enter the WIFI name and password, then press "Next" button for pairing.
- Press the **Blink Quickly** button for "P0", device being added.
- When complete, display on control panel shows "P4", LED Ember-light shows **GREEN** color and flashes 6 times.

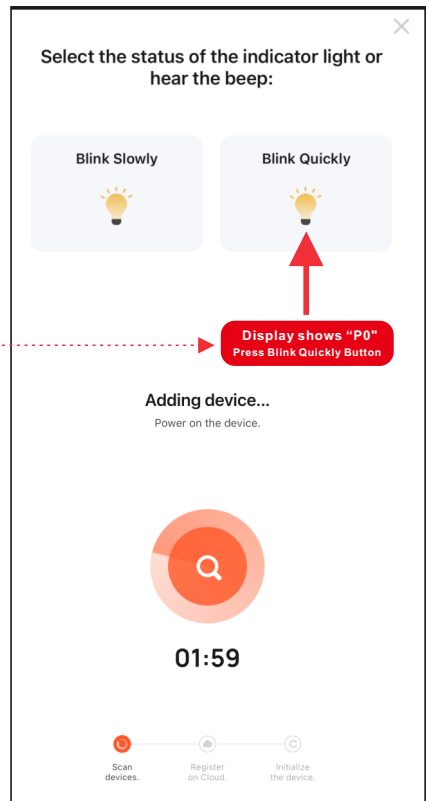
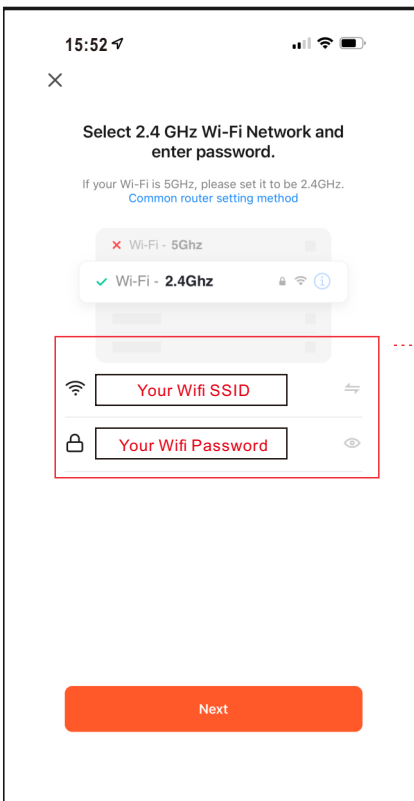
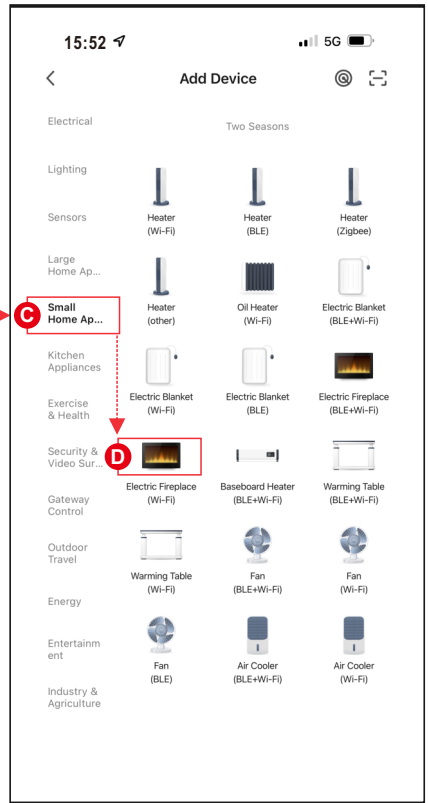
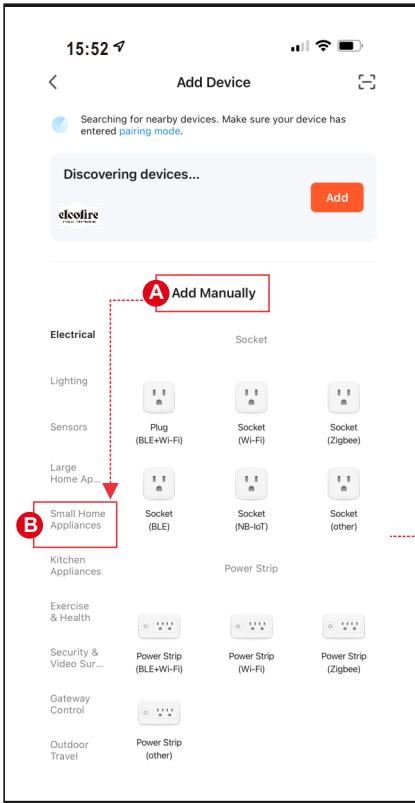
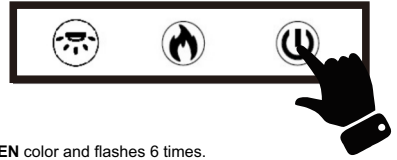

Add device - method 3 - (P1)

- Press & hold  from remote control or control panel until display on control panel shows "P1". Then follow below steps A,B,C,D.
- Enter the WIFI name and password, then press "Next" button for pairing.
- Press the **Blink Slowly** button for "P1", device being added.
- Select device's hotspot (**SmartLife-xxxx**), then back to device. Device being added.
- When complete, display on control panel shows "P4", LED Ember-light shows **GREEN** color and flashes 6 times.

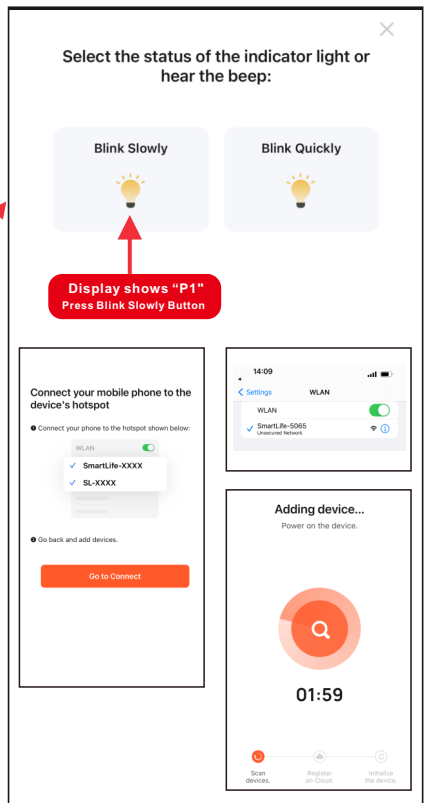
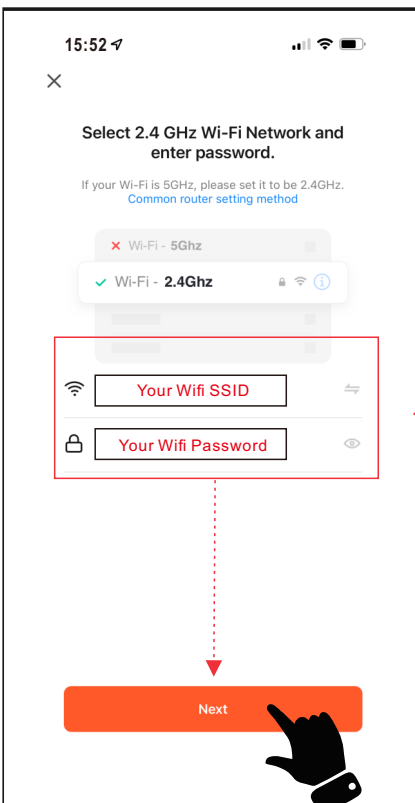
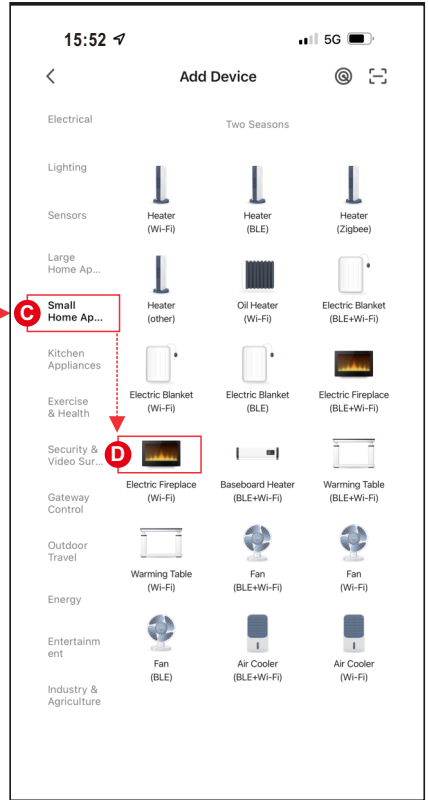
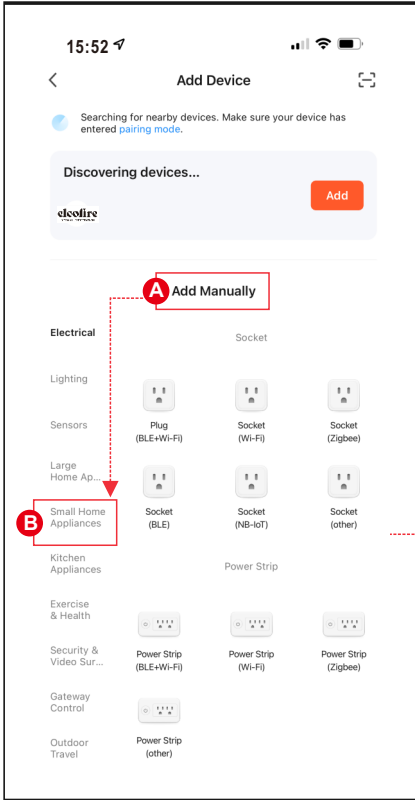
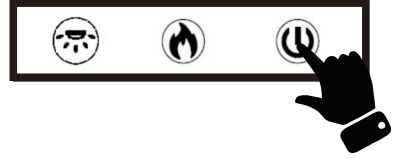

5. Complete

- Press **Done** to complete.

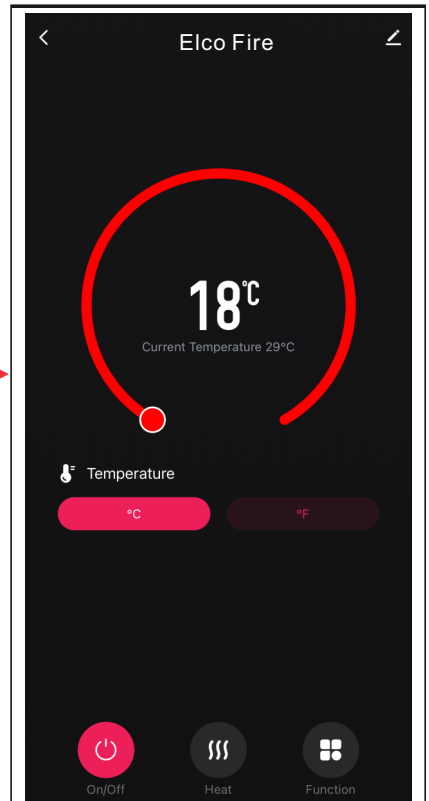
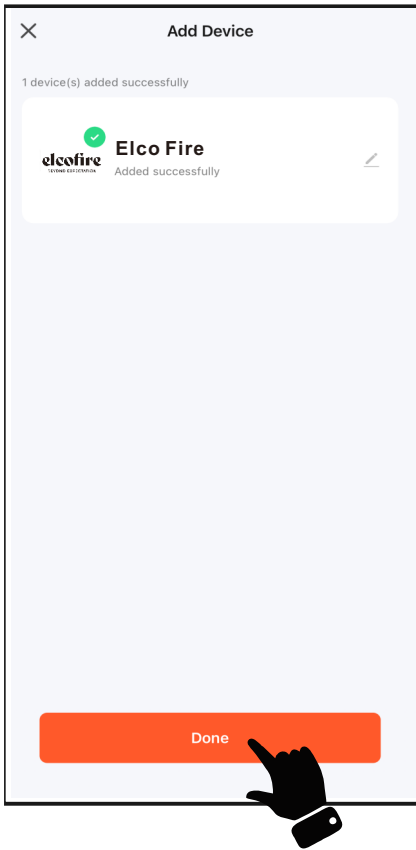

APP Operating Instruction

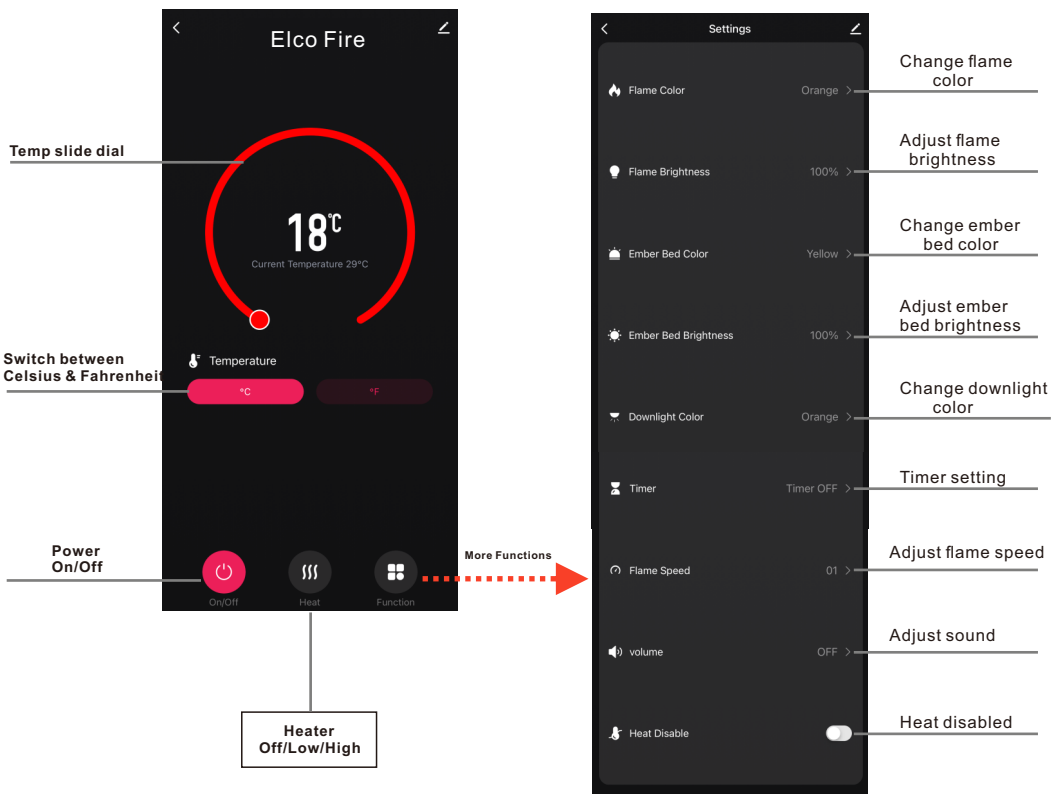

NOTE Only one device can be paired through the APP at a time.