

WALL RECESSED ELECTRIC FIREPLACE

Model# : ■ EFM700 ■ EFM1100 ■ EFM1500

OWNER'S MANUAL

eleofire

BEYOND EXPECTATION



AC 220-240V 50Hz 1400-1600W

⚠ WARNING

Read and understand this entire owner's manual, including **all safety information**, before plugging in or **using** this product. Failure to do so could result in **fire, electric shock, or serious personal injury**.

⚠ CAUTION

Keep this owner's manual for future reference. If you sell or give this product away, **make sure this manual accompanies this product**.



IMPORTANT SAFETY INFORMATION!

WARNING

When using electrical appliances basic precautions should always be followed to reduce the risk of fire, electric shock and injury to persons, including the following:

- Read all instructions before using this heater.
- This heater is hot when in use. To avoid burning, do not touch hot surface. If provided, use handles when moving this heater. Keep combustible materials, such as furniture, pillows, bedding, papers, clothes, and curtains at least 1 m from the front of the heater and keep them away from the sides and rear. In order to avoid overheating, do not cover the heater.
- Extreme caution is necessary when any heater is used near children or the infirm and whenever the heater is left operating and unattended.
- Always unplug heater when not in use.
- Do not operate any heater with a damaged cord or plug or after the heater malfunctions, has been dropped damaged in any manner, return heater to authorized service facility for examination, electrical or mechanical adjustment, or repair.
- Indoor use only, do not use outdoors.
- This heater is not intended for use in bathrooms, laundry areas and similar indoor locations. Never locate heater where it may fall into a bathtub or other water container.
- Do not run cord under carpeting. Do not cover cord with throw rugs, runners, or similar coverings. Arrange cord away from traffic area and where it will not be tipped over.
- To disconnect heater, turn controls to off, then remove plug from outlet.
- Do not inset or allow foreign objects to enter any ventilation or exhaust opening as this may cause an electric shock or fire, or damage the heater.
- To prevent a possible fire, do not block air intakes or exhaust in any manner. Do not use on soft surfaces, like a bed, where openings may become blocked.
- A heater has hot and arcing or sparking parts inside. Do not use it in areas where gasoline, or flammable liquids are used or stored.
- Use this heater only as describes in this manual. Any other use not recommended by the manufacturer may cause fire, electric shock, or injury to persons.
- DANGER-HIGH Temperatures may be generated under certain abnormal conditions. Do not partially or fully cover or obstruct the front of this heater.
- Replacement of the lamps should be done only while the heater is disconnected from the supply circuit.
- This appliance is not intended for use by persons (including children) with reduced physical, sensory or capabilities, or lack of experience and knowledge, unless they have been given supervision or instruction concerning use of the appliance by a person responsible for their safety. Children should be supervised to ensure that they do not play with the appliance.
- CAUTION: In order to avoid a hazard due to inadvertent resetting of the thermal cut-out, this appliance must not be supplied through an external switching device, such as a timer, or connected to a circuit that is regularly switched on and off by the utility.

Preparation







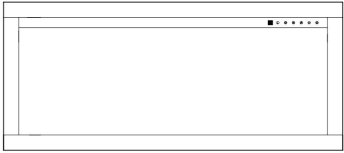

This product includes a **GLASS** panel. Always use **extreme caution** when handling **glass**. Failure to do so could result in **personal injury** or **property damage**.

Remove all parts and hardware from the carton and place them on a clean, soft, dry surface. Parts and assembly steps are grouped for wall-hanging or recessing use. Check the parts list to make sure nothing is missing. Dispose of packaging materials properly. Please recycle whenever possible.

You will need the following tools (not included): Phillips screwdriver, stud finder, level, tape measure, electric drill, 1/4" wood drill bit, hammer.

Parts and Hardware

 <p>A</p>	 <p>B- Wood Screw</p>	 <p>C-Remote Control</p>	 <p>D-Lit Log-set</p>
 <p>E-Smoked Crystals</p>	 <p>F-Instruction Manual</p>		

Specification and Dimensions

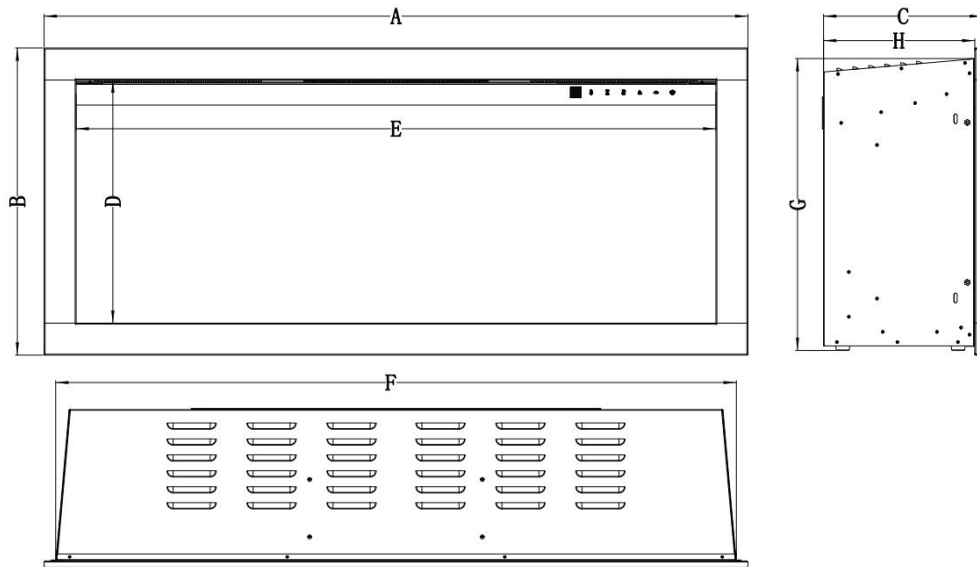

PRODUCT DIMENSIONS (mm)

Model Number	A	B	C	D	E	F	G	H
EFM700	27-9/16" [700mm]	18-7/8" [480mm]	9-7/8" [250mm]	15" [380mm]	23-5/8" [600mm]	26-1/8" [664mm]	18" [458mm]	9-3/8" [238mm]
EFM1100	43-5/16" [1100mm]	18-7/8" [480mm]	9-7/8" [250mm]	15" [380mm]	39-3/8" [1000mm]	41-7/8" [1064mm]	18" [458mm]	9-3/8" [238mm]
EFM1500	59" [1500mm]	18-7/8" [480mm]	9-7/8" [250mm]	15" [380mm]	55-1/8" [1400mm]	57-5/8" [1464mm]	18" [458mm]	9-3/8" [238mm]

Installation and Assembly

This appliance is designed to be **recess mounted** or **slide-in mounted** (slid into an existing fireplace). It can also be **hardwired** or **plugged into a receptacle** (power cord supplied). Select a suitable location that is not susceptible to moisture and is away from drapes, furniture and high traffic areas.

NOTE: Follow all National and local electrical codes.

MINIMUM CLEARANCE TO COMBUSTIBLES

Measurements are taken from the glass front.

Bottom	0"	Top	11.8" (300mm) to mantel
Sides	0"	Top	11.8" (300mm) to ceiling
Back	0"		

WARNING

WHEN USING PAINT OR LACQUER TO FINISH THE MANTEL, THE PAINT OR LACQUER MUST BE HEAT RESISTANT TO PREVENT DISCOLOURATION.

Power

Plug the power cord into a dedicated 220-240 Volt 15 Amp grounded outlet (see **IMPORTANT SAFETY INFORMATION** on **Pages 2 and 3**). Make sure the outlet is in good condition and the plug is not loose. **NEVER** exceed the maximum amperage for the circuit. **DO NOT** plug other appliances into the same circuit.

Pre-installation Built-in

Due to the many different materials used on different walls, it is highly recommended that you consult your local builder before you install this appliance.

- A. Select a location that is not prone to moisture and is located at least 36" (94.1cm) away from combustible materials such as curtain drapes, furniture, bedding, paper, etc.
- B. Create a rough-in frame with electrical (see below "framing").
- C. Remove the front glass (see "front glass removal / installation" section).
- C. Hold the appliance up to ensure it will fit into the framing.

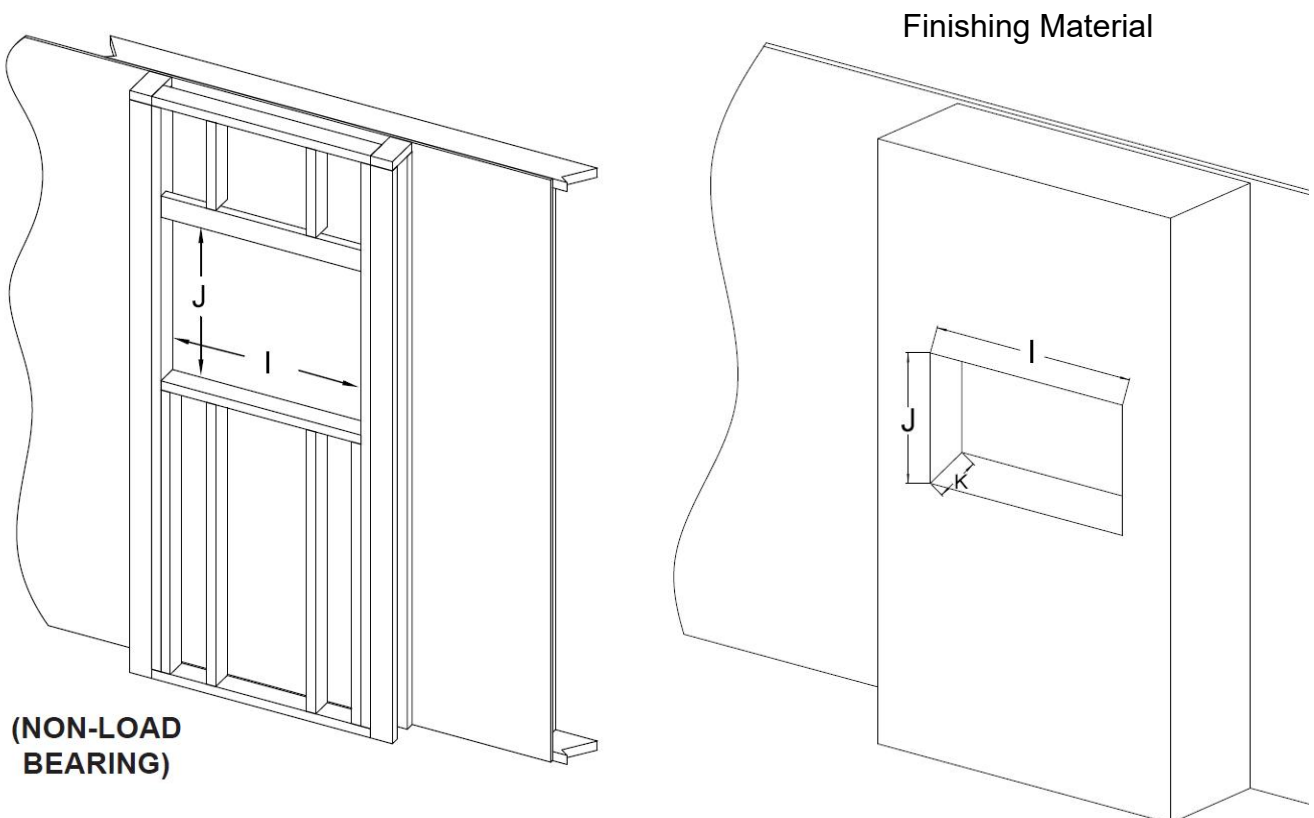

Framing Hole Size			
Model Number	I	J	K
EFM700	26-3/8" [670mm]	18-1/4" [464mm]	10" [254mm]
EFM1100	42-1/8" [1070mm]	18-1/4" [464mm]	10" [254mm]
EFM1500	57-7/8" [1470mm]	18-1/4" [464mm]	10" [254mm]

Front Trim Removal

- Take off the screws on both side.(Fig. 1-1)
- Carefully lift the front trim up and away from the appliance (Fig. 1-2). Place it face down on a soft, non-abrasive surface.
- Reverse these steps to install the front trim.

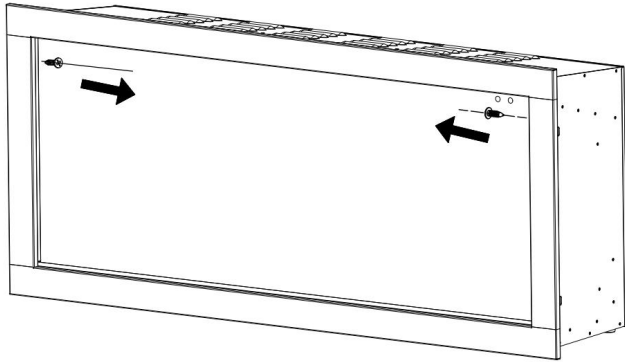

Fig. 1-1

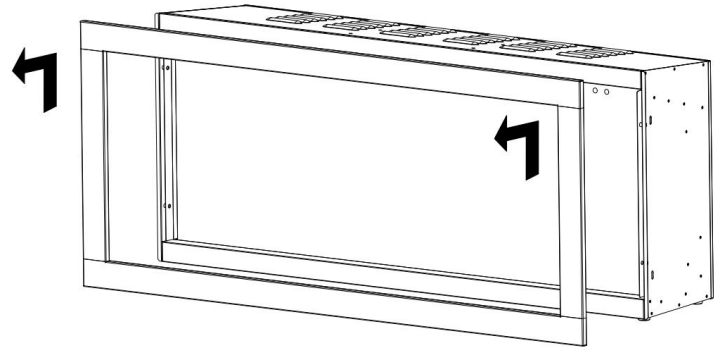

Fig. 1-2

Front Glass Panel Removal

- Take off the screws on both side.(Fig. 2-1)
- Carefully take the metal bracket(s) away from the appliance. Place it face down on a soft, non-abrasive surface. (Fig. 2-2)

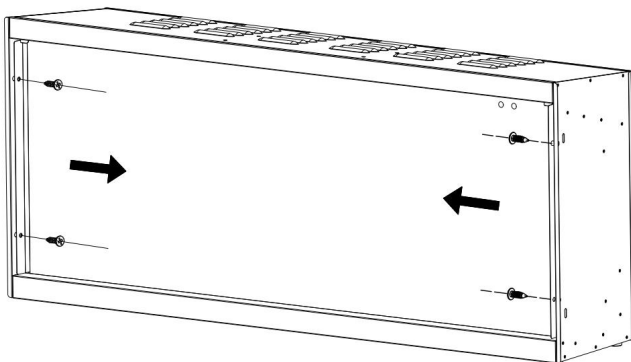

Fig. 2-1

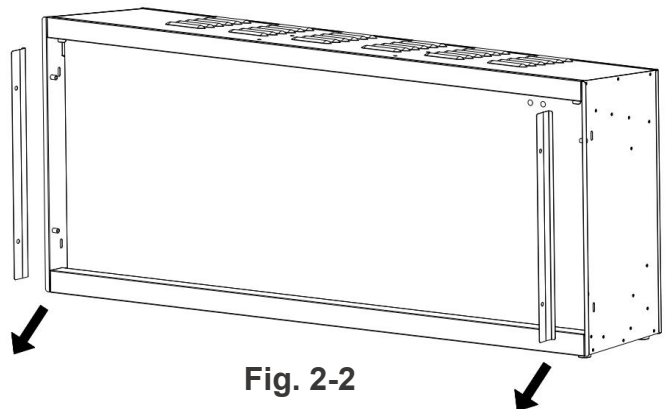

Fig. 2-2

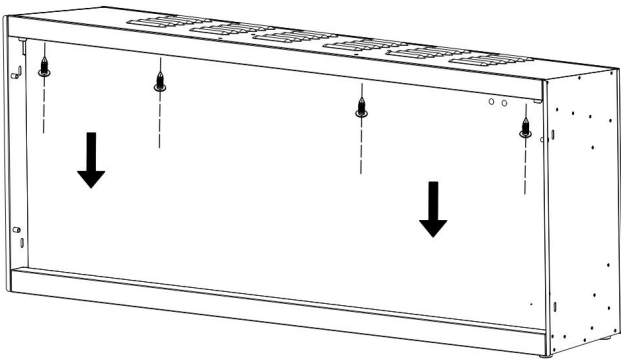

Fig. 2-3

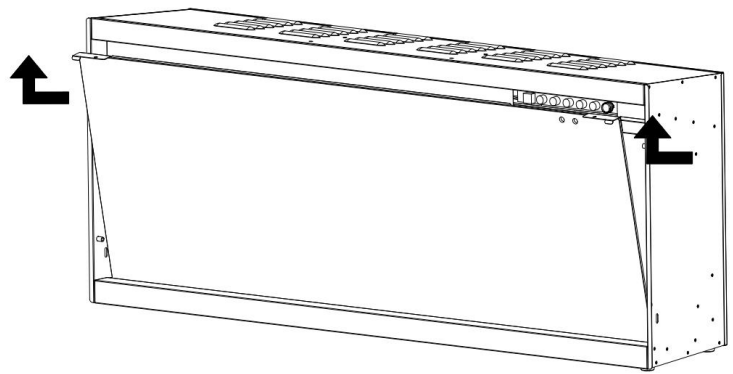

Fig. 2-4

C. With one hand on the front glass to prevent it from falling, remove the screws from the top of the glass. Set the screws aside. (Fig. 2-3)

D. Carefully lift the front glass up and away from the appliance. Place it face down on a soft, non-abrasive surface. (Fig. 2-4)

E. Reverse these steps to install the front glass.

Wall Recessed installation

A. Power the fireplace by plug-into the wall receptacle.

B. Insert the fireplace into the rough-in frame and then secure it by installing 4 wood screws (B) through the holes (Fig. 3-1, Fig 2-2).

C. Installed the lit-log, and put the smoked crystals to the ember bed, then re-install the front glass and front trim. See below section for log-set, crystals installation.

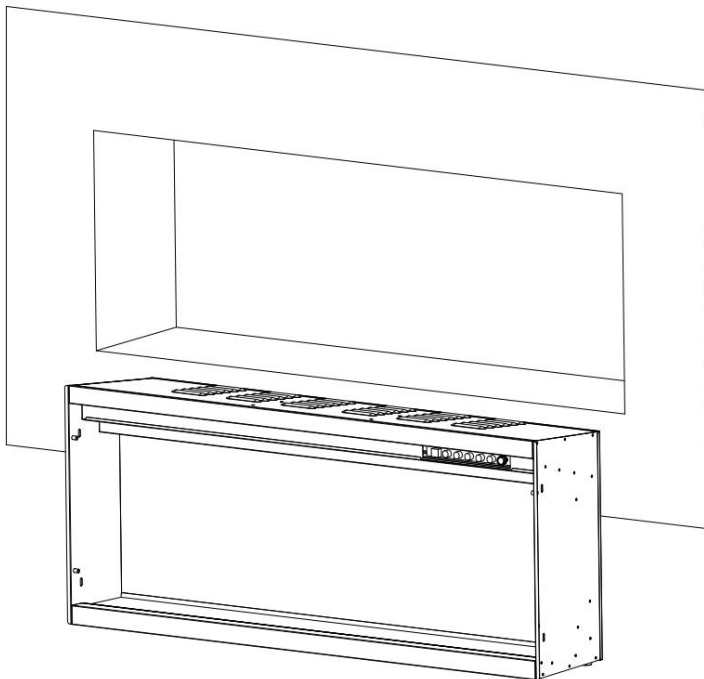

Fig. 3-1

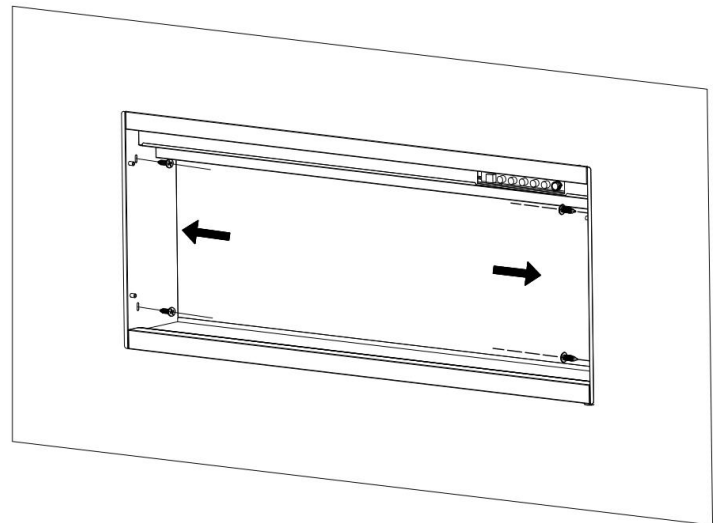

Fig. 3-2

Decorative Crystals & Log-set Installation

- Install logs first. Connect log-set (D) by plugging the connector to the socket as shown below.
- Carefully place smoked crystals (E) onto the ember bed strip as Fig.4-1. Apply an even layer from side to side.

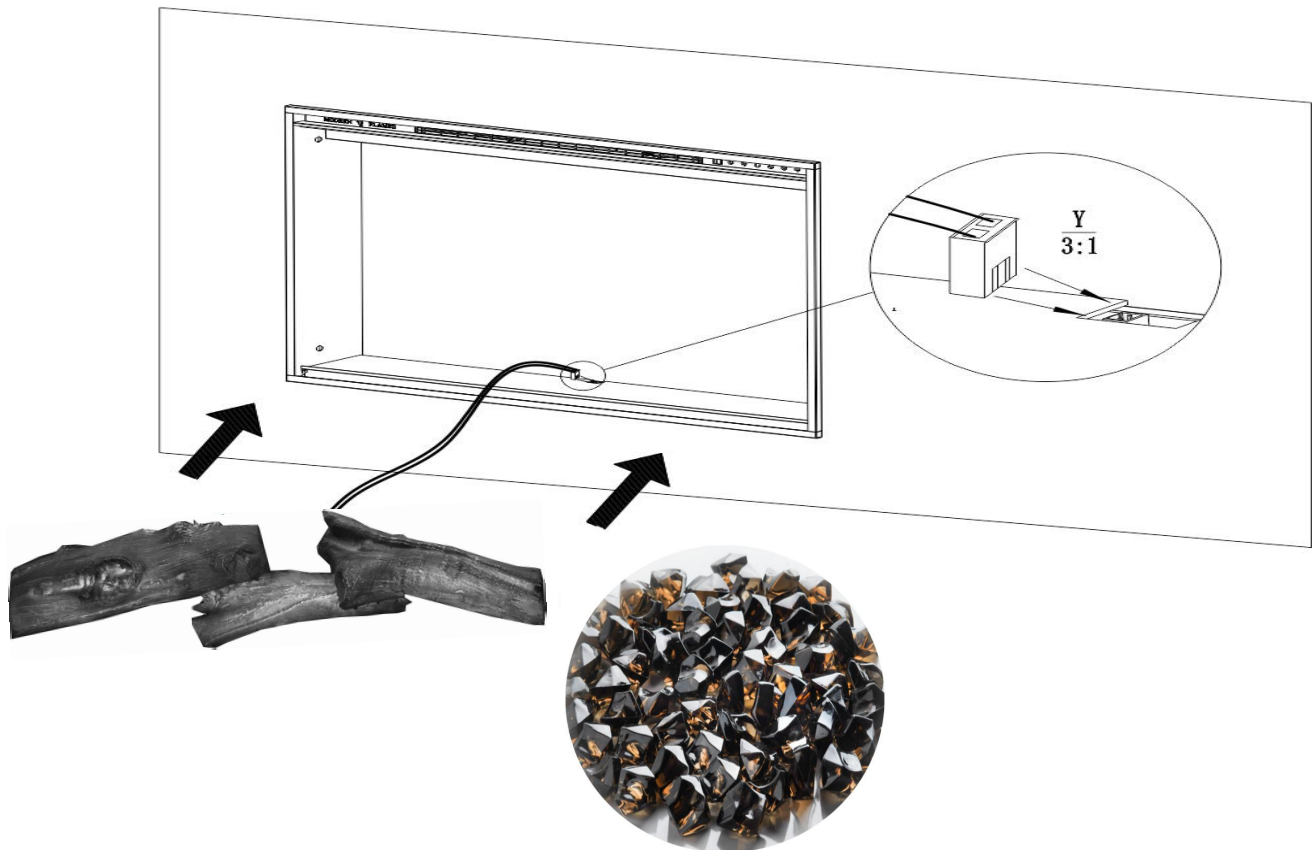

Fig.4-1



Finished Effect

Operation



Read and understand this entire owner's manual, including all safety information, before plugging in or using this product. Failure to do so could result in electric shock, fire, serious injury, or death.

Methods of Operation

This electric fireplace can be operated by the CONTROL PANEL, located on the UPPER right corner of the fireplace or by the battery-powered REMOTE CONTROL.



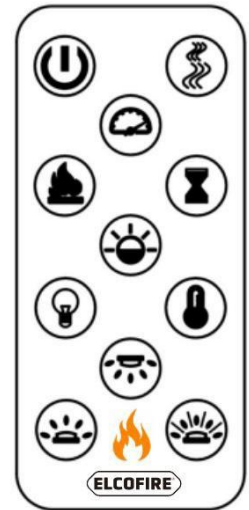

Control Panel



Remote control

Control Panel Operation





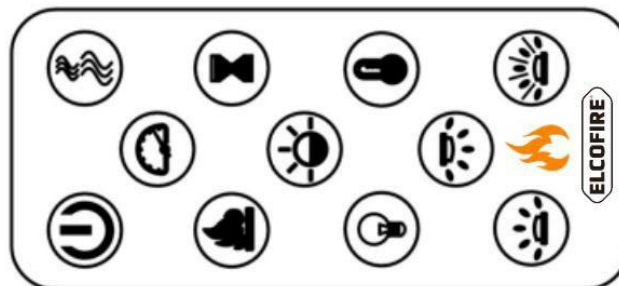

BUTTON	FUNCTION	ACTION & INDICATION
 POWER	<p>ON: Enables control panel functions and remote control. Turns on flame.</p> <p>OFF: Disables control panel functions and remote control. Turns off flame.</p>	<ol style="list-style-type: none"> Press once: Indicator light turns on. Power turns on. All functions enabled. Press again: Flame turns off. Unit goes to standby. All functions turn off.
 FLAME BRIGHTNESS	<p>FLAME brightness button: Makes flame dimmer and brighter.</p>	<ol style="list-style-type: none"> Press once: Flame brightness enabled. Press again until desired setting is reached. F5-F4-F3-F2-F1-F0(OFF)
 FLAME	<p>FLAME button: Changes flame color.</p>	<ol style="list-style-type: none"> Press once: Flame color illuminates. Press again until desired color is reached. In total 10 colors 01-02-03-04-05-06-07-08-09-10





 HEATER	<p>HEATER button: Turns heater on and off.</p> <p>NOTE: The heater only works when the flame is on. If the flame is off, the heater will not turn on.</p> <p>NOTE: To prevent overheating, the heater fan will blow cool air for 8-10 seconds after the heater turns off.</p>	<p>Turns the heater and blower on/off.</p> <p>Settings:</p> <p>H0 - Heater and blower off</p> <p>H1 - Low Heater on with 750W</p> <p>H2 - High Heater on with 1500W</p> <p>NOTE: Press and hold the heater button for 5 seconds to lock/unlock the heater and thermostat.</p>																																							
 TIMER	<p>TIMER button: Controls timer settings to turn off fireplace at selected time.</p> <p>Settings range from 30 min to 8 hours.</p>	<ol style="list-style-type: none"> Press once: Indicator light turns on. Timer defaults to 30 min. Press again until desired setting is reached. 																																							
 TEMP	<ol style="list-style-type: none"> Press once: Touch panel indicator becomes active. Press again until desired temperature is reached. Digital display shows settings 0-10. <p>Table below shows corresponding temperatures:</p> <table border="1" data-bbox="267 840 1502 987"> <thead> <tr> <th>NO</th> <th>0</th> <th>1</th> <th>2</th> <th>3</th> <th>4</th> <th>5</th> <th>6</th> <th>7</th> <th>8</th> <th>9</th> <th>10</th> <th>N</th> </tr> </thead> <tbody> <tr> <td>°C</td> <td>20</td> <td>21</td> <td>22</td> <td>23</td> <td>24</td> <td>25</td> <td>26</td> <td>27</td> <td>28</td> <td>29</td> <td>30</td> <td>C</td> </tr> <tr> <td>°F</td> <td>68</td> <td>70</td> <td>72</td> <td>74</td> <td>76</td> <td>78</td> <td>80</td> <td>82</td> <td>84</td> <td>86</td> <td>88</td> <td>F</td> </tr> </tbody> </table> <p>NOTE: Press the button for 5 seconds to switch between ° C and ° F.</p>		NO	0	1	2	3	4	5	6	7	8	9	10	N	°C	20	21	22	23	24	25	26	27	28	29	30	C	°F	68	70	72	74	76	78	80	82	84	86	88	F
NO	0	1	2	3	4	5	6	7	8	9	10	N																													
°C	20	21	22	23	24	25	26	27	28	29	30	C																													
°F	68	70	72	74	76	78	80	82	84	86	88	F																													



Remote Control Operation

BUTTON	FUNCTION	ACTION & INDICATION
 POWER	<p>ON: Enables control panel functions and remote control. Turns on flame.</p> <p>OFF: Disables control panel functions and remote control. Turns off flame.</p>	<ol style="list-style-type: none"> Press once: Indicator light turns on. Power turns on. All functions enabled. Press again. Flame turns off. Unit goes to standby. All functions turn off.

 <p>FLAME SPEED</p>	<p>Flame speed button: Controls the speed of the flame. There are 4 flame speed settings. The Default setting is 03 (medium speed)</p>	<p>1. Press once: Indicates current flame speed.</p> <p>2. Press again until desired setting is reached. Display shows the setting. 01 (Slowest), 02 (Medium), 03 (Fast), 04(Turbo)</p>
 <p>FLAME</p>	<p>FLAME button: Changes flame color.</p>	<p>1. Press once: Flame color illuminates.</p> <p>2. Press again until desired color is reached. In total 10 colors. 01-02-03-04-05-06-07-08-09-10</p>
 <p>FLAME BRIGHTNESS</p>	<p>FLAME brightness button: Makes flame dimmer and brighter.</p>	<p>1. Press once: Flame brightness enabled.</p> <p>2. Press again until desired setting is reached. F5-F4-F3-F2-F1-F0(OFF)</p>
 <p>HEATER</p>	<p>HEATER button: Turns heater on and off.</p> <p>NOTE: The heater only works when the flame is on. If the flame is off, the heater will not turn on.</p> <p>NOTE: To prevent overheating, the heater fan will blow cool air for 8-10 seconds after the heater turns off.</p>	<p>Turns the heater and blower on/off.</p> <p>Settings:</p> <p>H0 - Heater and blower off</p> <p>H1 - Low Heater on with 750W</p> <p>H2 - High Heater on with 1500W</p> <p>NOTE: Press and hold the heater button for 5 seconds to lock/unlock the heater and thermostat.</p>
 <p>TIMER</p>	<p>TIMER button: Controls timer settings to turn off fireplace at selected time. Settings range from 30 min to 8 hours.</p>	<p>1. Press once: Indicator light turns on. Timer defaults to 30min.</p> <p>2. Press again until desired setting is reached.</p>
 <p>EMBER-BED</p>	<p>EMBER BED button: Turns on media bed and changes color.</p>	<p>1. Press once: Turns on ember bed.</p> <p>2. Press again until desired color is reached. in total 10 colors. 01-02-03-04-05-06-07-08-09-10-11 (Auto Cycle).</p>

 <p>EMBER-BED BRIGHTNESS</p>	<p>EMBER BED brightness button: Makes media bed dimmer and brighter.</p>	<p>1. Press once: Brightness becomes active. 2. Press again until desired setting is reached. In total 4 levels and 1 pulsating. From L5-L4-L3-L2-L1 (Pulsating)-L0(OFF)</p>																																							
 <p>TEMP</p>	<p>1. Press once: Touch panel indicator becomes active. 2. Press again until desired temperature is reached. Digital display shows settings 0-10. Table below shows corresponding temperatures:</p> <table border="1" data-bbox="269 606 1511 751"> <tr> <td>NO</td> <td>0</td> <td>1</td> <td>2</td> <td>3</td> <td>4</td> <td>5</td> <td>6</td> <td>7</td> <td>8</td> <td>9</td> <td>10</td> <td>N</td> </tr> <tr> <td>°C</td> <td>20</td> <td>21</td> <td>22</td> <td>23</td> <td>24</td> <td>25</td> <td>26</td> <td>27</td> <td>28</td> <td>29</td> <td>30</td> <td>C</td> </tr> <tr> <td>°F</td> <td>68</td> <td>70</td> <td>72</td> <td>74</td> <td>76</td> <td>78</td> <td>80</td> <td>82</td> <td>84</td> <td>86</td> <td>88</td> <td>F</td> </tr> </table> <p>NOTE: Press the button for 5 seconds to switch between ° C and ° F.</p>		NO	0	1	2	3	4	5	6	7	8	9	10	N	°C	20	21	22	23	24	25	26	27	28	29	30	C	°F	68	70	72	74	76	78	80	82	84	86	88	F
NO	0	1	2	3	4	5	6	7	8	9	10	N																													
°C	20	21	22	23	24	25	26	27	28	29	30	C																													
°F	68	70	72	74	76	78	80	82	84	86	88	F																													
 <p>LIT-LOG</p>	<p>LIT LOGSET brightness button: Makes log-set dimmer and brighter.</p>	<p>1. Press once: Brightness becomes active. 2. Press again until desired setting is reached. In total 4 levels and 1 pulsating. From E5-E4-E3-E2-E1 (Pulsating)-E0(OFF)</p>																																							
 <p>DOWN-LIGHT</p>	<p>DOWN LIGHT button: Turns on LED down light and changes color.</p>	<p>1. Press once: Turns on led down light.. 2. Press again until desired color is reached.in total 10 colors. 01-02-03-04-05-06-07-08-09-10-11(Auto Cycle)-00(OFF)</p>																																							
	<p>Press the “HOME” button returns all functions to factory default.</p>																																								

NOTICE When the heater is first turned on, a slight odor may be present. This is normal and should not occur again unless the heater is not used for a long period of time.

NOTICE To improve operation, **aim** the remote control at the front of the fireplace. **DO NOT press the buttons too quickly.** Give the unit time to respond to each command.

Temperature Limiting Control

This heater is equipped with a Temperature Limiting Control. Should the heater reach an unsafe temperature, the heater will automatically turn OFF. To reset:

1. Remove the power from the appliance. Wait 5 minutes.
2. Inspect the fireplace to make sure no vents are blocked or clogged with dust or lint. If they are, use a vacuum to clean the vent areas.
3. Apply power to the appliance.
4. If the problem continues, have your outlet and wiring inspected by a professional.

Remote Control Battery Information

- Remote control uses one **CR2025** battery (**Included**)



NEVER dispose of batteries in **fire**. Failure to observe this precaution **may result in an explosion**. Dispose of batteries at your local hazardous material processing center.

Care and Maintenance

Cleaning



ALWAYS turn the heater **OFF** and **remove the power from the appliance** before cleaning, performing maintenance, or moving this fireplace. Failure to do so could result in **electric shock, fire, or personal injury**.



NEVER immerse in water or **spray with water**. Doing so could result in **electric shock, fire, or personal injury**.

Metal:

- Clean using a soft cloth, slightly dampened with soapy water.
- **DO NOT** use brass polish or household cleaners as these products will damage the metal trim.

Glass:

- Use a good quality glass cleaner sprayed onto the cloth or towel. Dry thoroughly with a paper towel or lint-free cloth.
- **NEVER** use abrasive cleansers, liquid sprays, or any cleaner that could scratch the surface.

Vents:

- Use a vacuum or duster to remove dust and dirt from the heater and vent areas.

Plastic:

- Wipe gently with a slightly damp cloth and a mild solution of dish soap and warm water.
- **NEVER** use abrasive cleansers, liquid sprays, or any cleaner that could scratch the surface.

Maintenance



Risk of electric shock! DO NOT OPEN any panels! No user-serviceable parts inside!



ALWAYS turn the heater **OFF** and **remove power from the appliance** before cleaning, performing maintenance, or moving this fireplace. Failure to do so could result in **electric shock, fire, or personal injury**.

Electrical and Moving Parts:

The fan motors are lubricated at the factory and will not require lubrication.

Electrical components are integrated in the fireplace and are not serviceable by the consumer.

Storage:

Store heater in a clean dry place when not in use.



WARNING! NO SERVICING of the internal or electrical parts should be performed by the consumer. Do not service the unit yourself.